

Automotive & Industrial Grade 32.768kHz SMD Low Profile Crystal

ABS07AIG

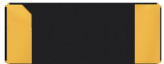

3.2 x 1.5 x 0.9 mm

ABS07AIG

Pb | **RoHS/RoHS II Compliant**

Moisture Sensitivity Level (MSL) – This product is Hermetically Sealed and not Moisture Sensitive - MSL = N/A: Not Applicable

- | | |
|--|---|
| <p>➤ FEATURES:</p> <ul style="list-style-type: none"> • PPAP ready and supported • TS16949 certified production lines • Miniature size and low profile package: 3.2 x 1.5 x 0.9mm • AEC-Q200 qualified • Hermetically sealed ceramic package assures high precision and reliability • Extended operating temperature range: -40°C to +125°C • RoHS compliant and Pb free | <p>➤ APPLICATIONS:</p> <ul style="list-style-type: none"> • Navigation • Car entertainment system • COTS Military • Test equipment • Industrial control • Medical Electronics (non-life dependent) • Comfort control • Instrument panel • Telematics • Industrial automation |
|--|---|

➤ **STANDARD SPECIFICATIONS:**

Parameters	Minimum	Typical	Maximum	Units	Notes
Frequency	32.768			kHz	
Operation Mode	Flexural Mode (Tuning Fork)				
Operating Temperature	-40		+125	°C	
Storage Temperature	-55		+125	°C	
Frequency Tolerance @+25°C	-20		+20	ppm	See options
Temperature Coefficient:	-0.040	-0.036		ppm/T ²	
Turn-over temperature:	+20	+25	+30	°C	
Equivalent series resistance (R1)			80	kΩ	
Shunt capacitance (C0)		1.1		pF	
Motional capacitance (C1)		4.7		fF	
Load capacitance (CL)	12.5			pF	See options
Drive Level		0.1	0.5	μW	
Q value	10000	30000			
Aging@25°C	-3		3	ppm	First year
Insulation Resistance	500			MΩ	

➤ **OPTIONS AND PART IDENTIFICATION: (left blank if standard)**

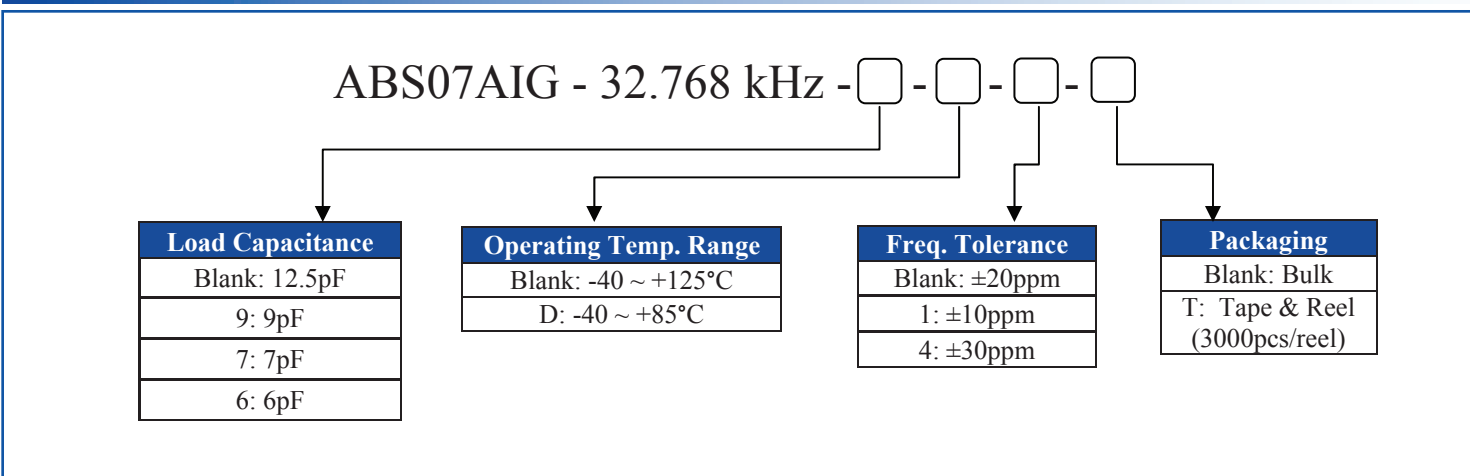

Automotive & Industrial Grade 32.768kHz SMD Low Profile Crystal

ABS07AIG

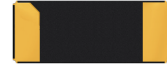

3.2 x 1.5 x 0.9 mm

ABS07AIG

 RoHS/RoHS II Compliant

OUTLINE DIMENSIONS:

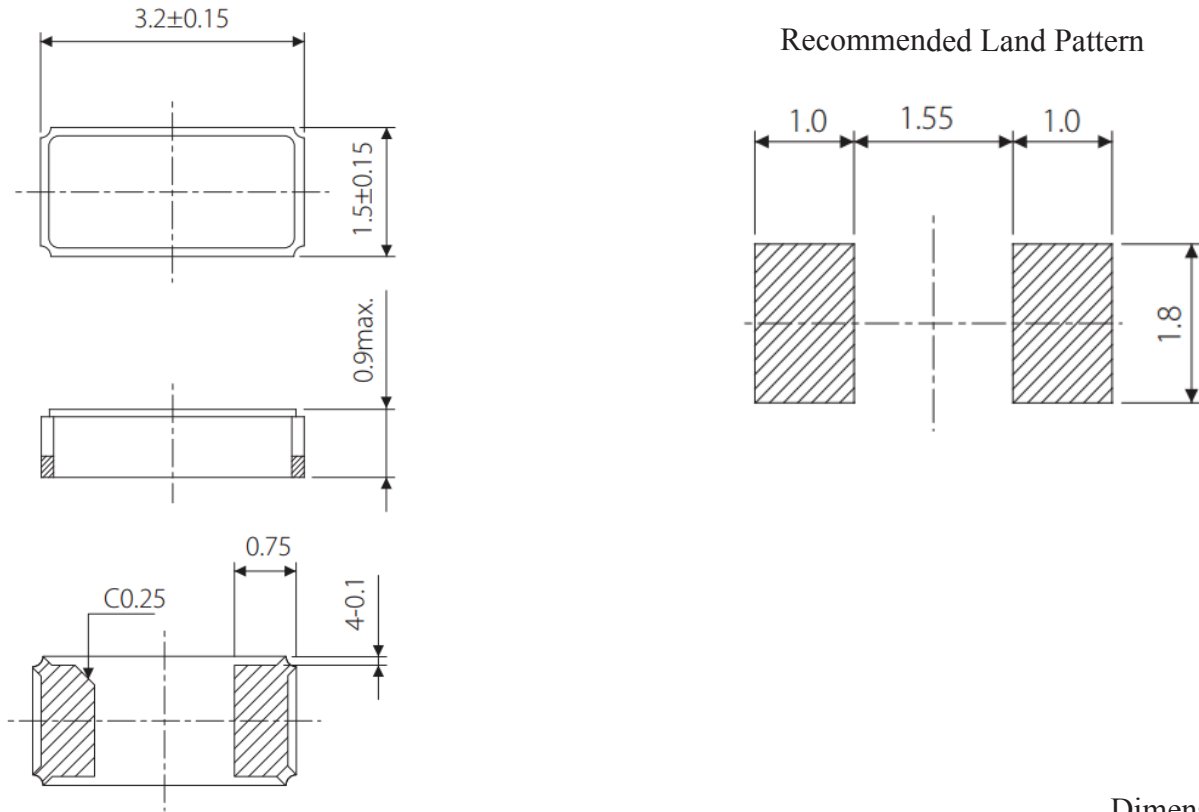

Dimensions: mm

REFLOW PROFILE:

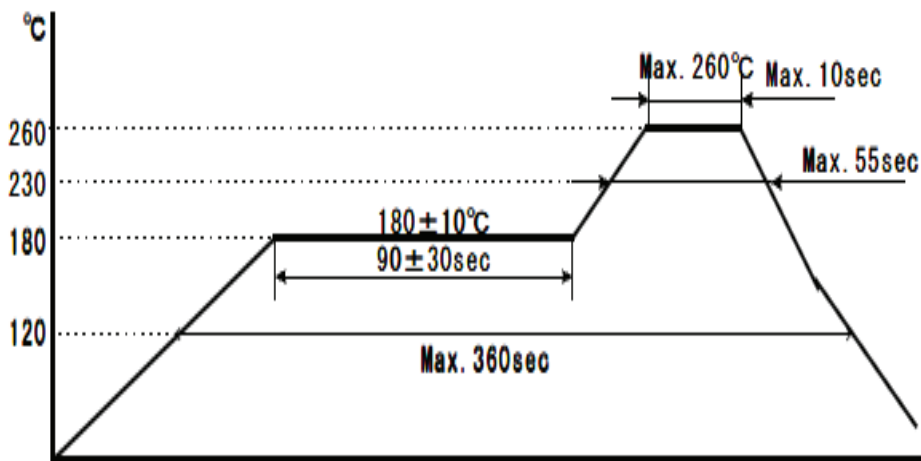

Automotive & Industrial Grade 32.768kHz SMD Low Profile Crystal

ABS07AIG



3.2 x 1.5 x 0.9 mm

ABS07AIG

RoHS/RoHS II Compliant

TAPE & REEL:

T=Tape and reel (3,000pcs/reel)

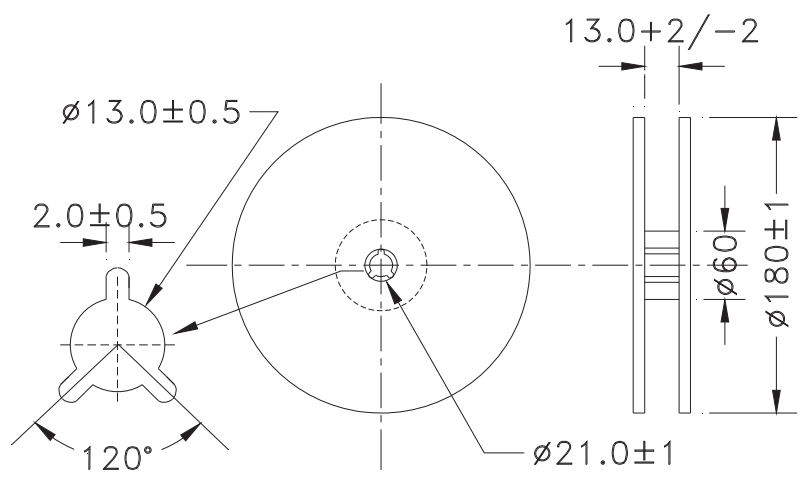
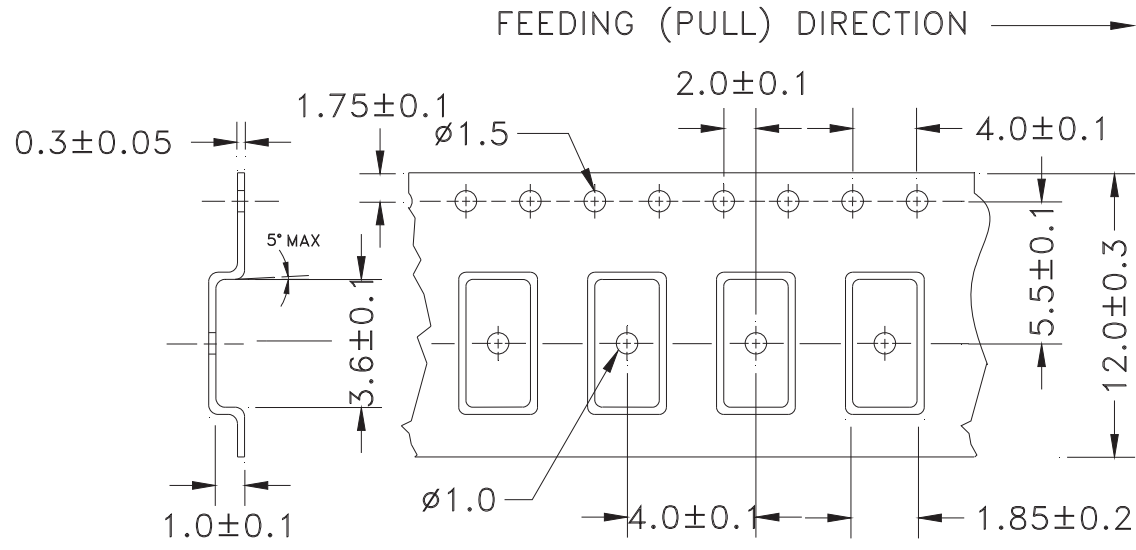

Dimensions: mm

ATTENTION: Abracon Corporation's products are COTS – Commercial-Off-The-Shelf products; suitable for Commercial, Industrial and, where designated, Automotive Applications. Abracon's products are not specifically designed for Military, Aviation, Aerospace, Life-dependant Medical applications or any application requiring high reliability where component failure could result in loss of life and/or property. For applications requiring high reliability and/or presenting an extreme operating environment, written consent and authorization from Abracon Corporation is required. Please contact Abracon Corporation for more information.



2 Faraday, Suite# B | Irvine | CA 92618 **Revised: 12.09.15**
 Ph. 949.546.8000 | Fax. 949.546.8001
 Visit www.abracon.com for Terms and Conditions of Sale

Pierce Analyzer System (PAS) Advanced Board Characterization Service

Abracon PAS System enables us to offer Automotive, Medical, and Industrial application customers a comprehensive, automated assessment of the Pierce Oscillator loop, in concert with the customers selected Quartz Crystal. The PAS System Circuit Analysis report is ideally suited for PPAP documentation, design history reporting, and overall assurance of a reliable optimized circuit.

Features:

- Circuit characterization; providing best possible match between Quartz Crystal, oscillator loop and associated components
- Eliminates probability of oscillator start-up issues related to inadequate design or marginal component performance
- Eliminates production launch issues related to crystal oscillator based timing circuit
- Solves design margin uncertainty

Deliverables: A detail Report encompassing:

• **Stand alone Quartz Crystal characteristics including:**

- Motional parameters (Cm, Lm, ESR & C0)
- Narrow Band Frequency Response Plot
- Wide Band Frequency Response Plot
- Admittance versus Susceptance plot
- Frequency dependence versus load capacitance plot

• **Oscillator loop characteristics including:**

- Initial frequency accuracy and drive level as seen by the crystal with measured ESR
- Worst case projected drive level with maximum specified ESR
- Safety Factor of the oscillator loop under both typical and maximum ESR
- Recommendation on proper component selection (C1, C2 & Rs when applicable) for best compromise with respect to Safety Factor and Frequency accuracy
- Recommendation on the Abracon Crystal part # with proper plating load and other key attributes to enable the most robust design, specific to the μ controller/processor implemented

Ordering information:

PAS-BC1WK	Analysis & Report with 1-week maximum lead-time
PAS-BC2WK	Analysis & Report with 2-week maximum lead-time
PAS-BC3WK	Analysis & Report with 3-week maximum lead-time

For detailed information, click here:



For additional information, please contact at: tech-support@abracon.com